

# Health Physics @ ZNA

## Implementing a health physics department

“DIENST FYSISCH E CONTROLE”

Jo Vanregemorter

hoofd dienst fysische controle  
ZIEKENHUISNETWERK ANTWERPEN



ZNA = network with  
 11 locations of which  
 8 with ionising radiation  
 7 FANC-licenced 'sites'  
 4 class III & 3 class II



# New rules december 2018

- Different options ...
- Several considerations ...
  - Internal HPD (Dienst Fysische Controle): of course!
  - Internal RPE or external?  
(QHPE 'erkend desk. klasse II')
  - Permanent availability RPE 24/7? How many RPE?
  - Radiation Protection Agents 'from scratch' or ... ? How many?  
(Agenten Stralingsbescherming)
  - Permanent availability RadProtAgents during operating hours?

# New rules december 2018

- Different options ...
- Several considerations ...
  - Internal HPD (Dienst Fysische Controle): of course! )
  - Internal RPE or external?  
(QHPE 'erkend desk. klasse II')
  - Permanent availability RPE 24/7? How many RPE?
  - Radiation Protection Agents 'from scratch' or ... ? How many?  
(Agenten Stralingsbescherming)
  - Permanent availability RadProtAgents during operating hours?

# Organising a Health Physics Dept slide from FANC (J. Berlamont)

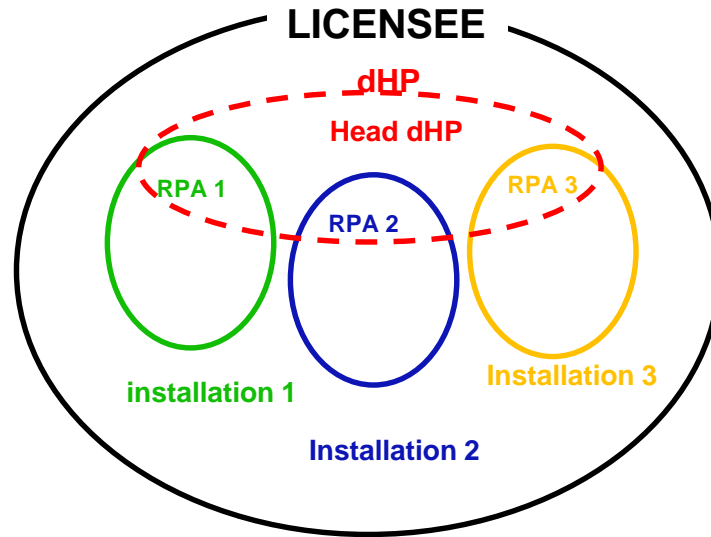

# For a network of hospitals (with one CEO)

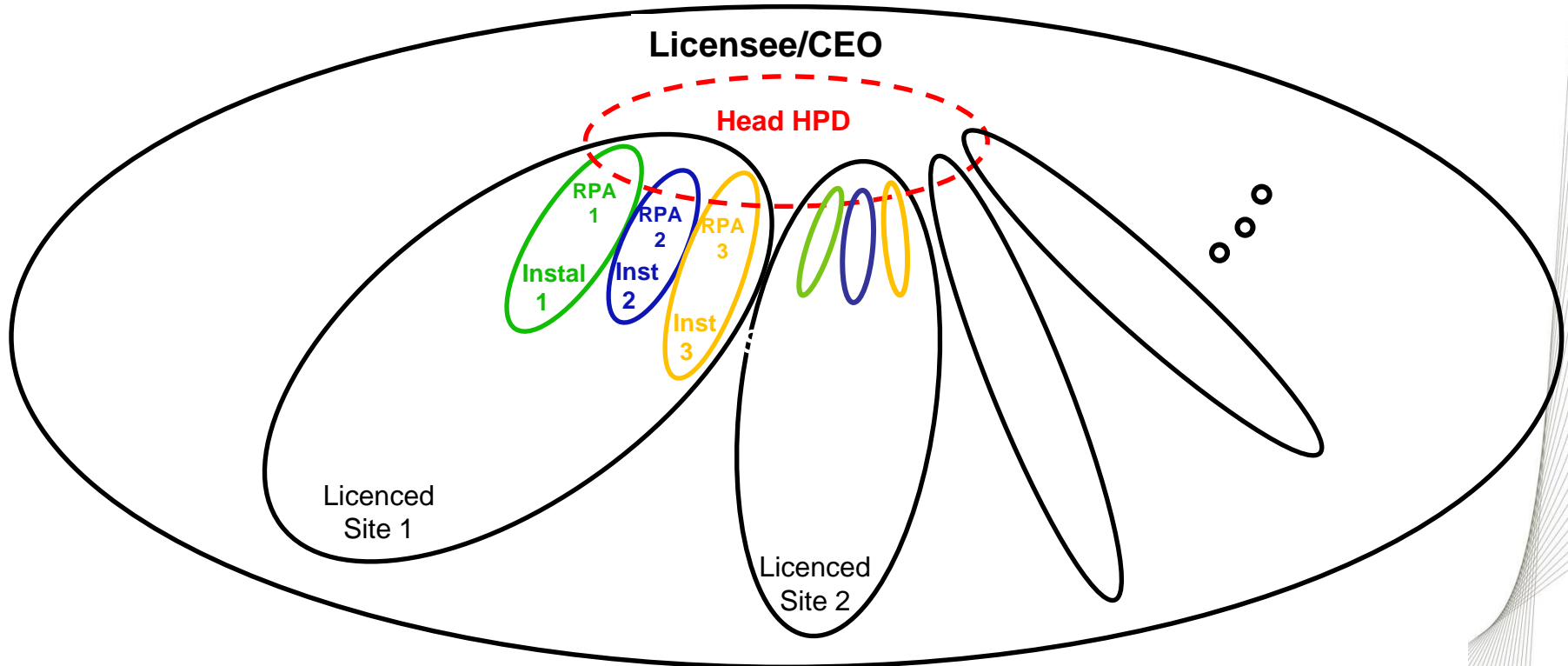

RPA = agent stralingsbescherming/agent de radioprotection

# New decree december 2018

- Different options
- Several considerations
  - Internal HPD (Dienst Fysische Controle) ✓
  - External RPE ✓  
(QHPE class II)
  - => Permanent availability RPE 24/7 ✓  
(approved establishment)
  - Radiation Protection Agents 'from scratch' or ... ? How many?  
(Agenten Stralingsbescherming)
  - Permanent availability RadProtAgents during operating hours?

# HPD ZNA

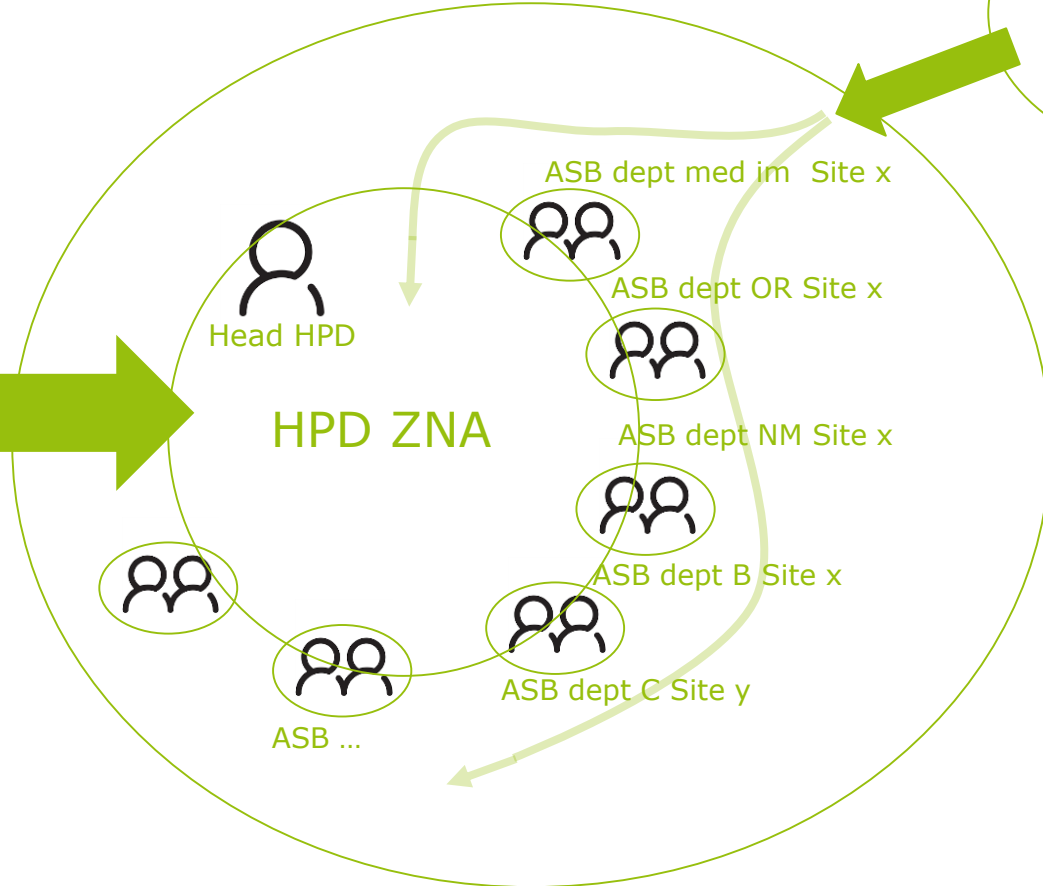

QHPE  
RPE

Erkende  
Instelling/  
Approved  
Establishment



De Agent Stralingsbescherming (ASB) is een medewerker van de afdeling die voor zijn taak/rol als ASB aangestuurd wordt door het hoofd van de DFC en daaraan rapporteert voor dat deel van zijn takenpakket.



# Radiation protection agents

- ▣ Eyes and ears on the floor
- ▣ Geographic location (eg CT is different floor/wing or not)  
(eg Day Hospital is next to general Operating Rooms or not)
- ▣ Risk analysis (eg dentist chair vs interventional cardiology)  
(eg Medical Imaging with or without CT)
- ▣ Operating hours 8hrs, 12hrs, ...

# Radiation protection agents

- ❑ RD: employee, no self-employed co-workers (so no MD's)
- ❑ ZNA: if possible the head nurse + ...
  
- ❑ Training:  
ZNA:
  - ❑ ART53 Nurse/Radiographer/... with Certification Radioprotection 50/60h
  - ❑ Additional 2 hours "update" (approved&presented) by the external RPE + written test
    - ❑ Nov/Dec 2019 ex-cathedra
    - ❑ From March 2020 onwards: on-line learning module + on-line test

# Organogram ZNA

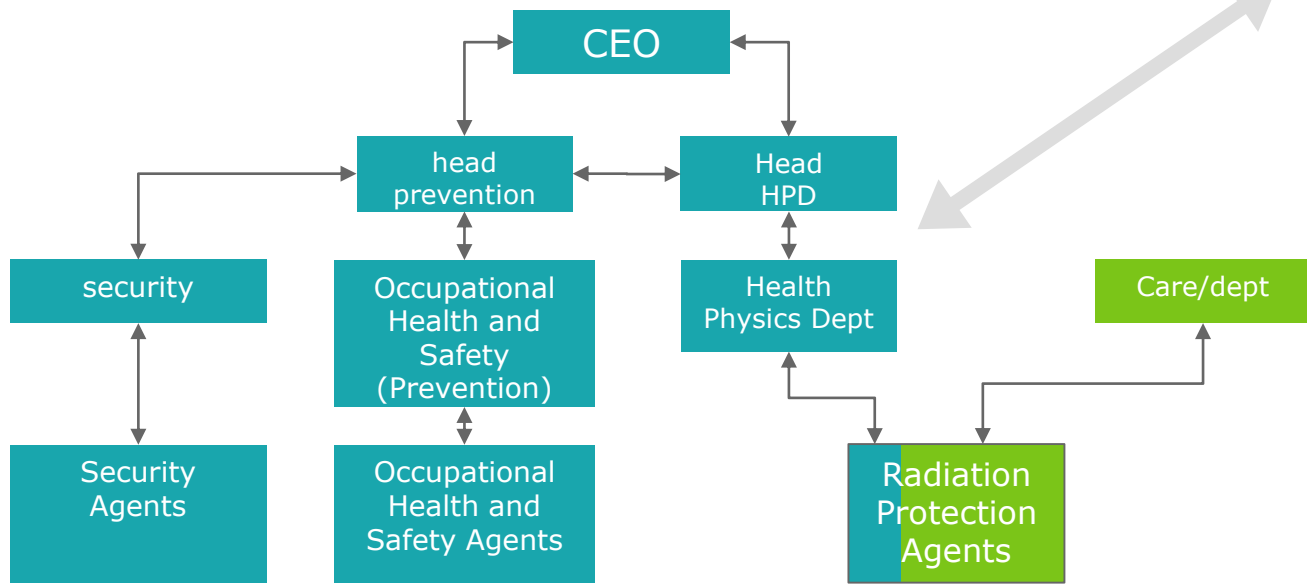

Approved establishment:  
- QHPE Erkend deskundige KL2  
- Permanentie 24/7  
- Inventory <-> fanc  
- Dosimetry <-> fanc



# Organogram ZNA

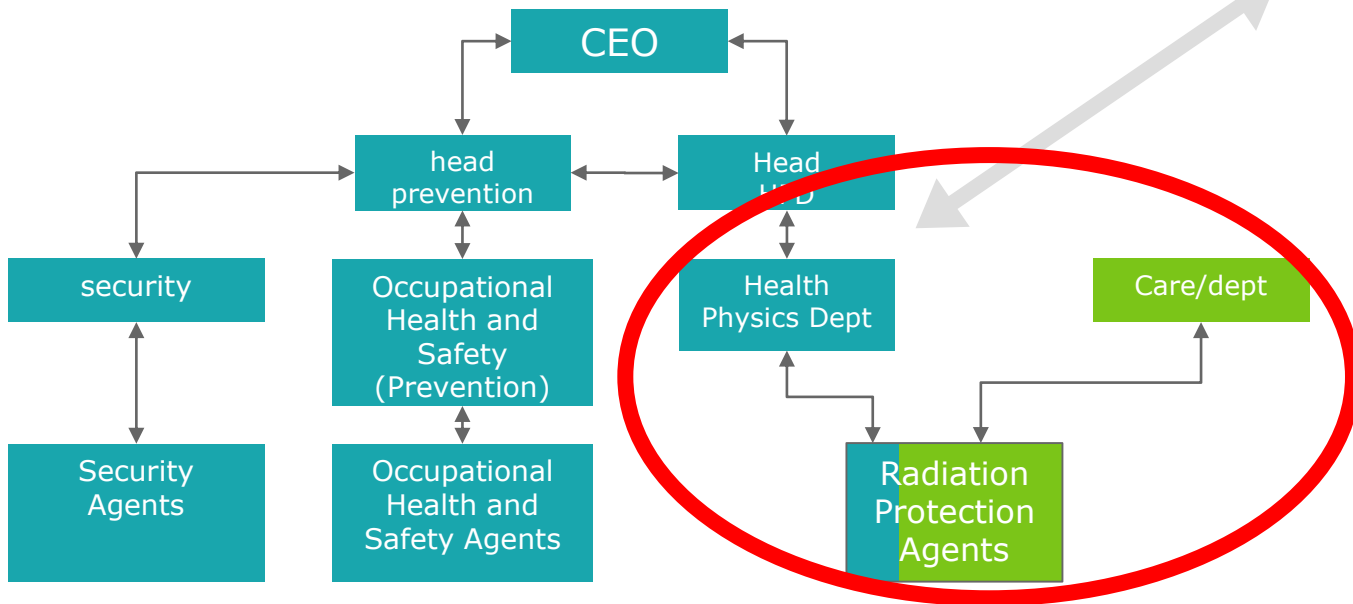

Approved establishment:

- QHPE Erkend deskundige KL2
- Permanentie 24/7
- Inventory <-> fanc
- Dosimetry <-> fanc

# Organogram (diensthoofd+32 ASb)

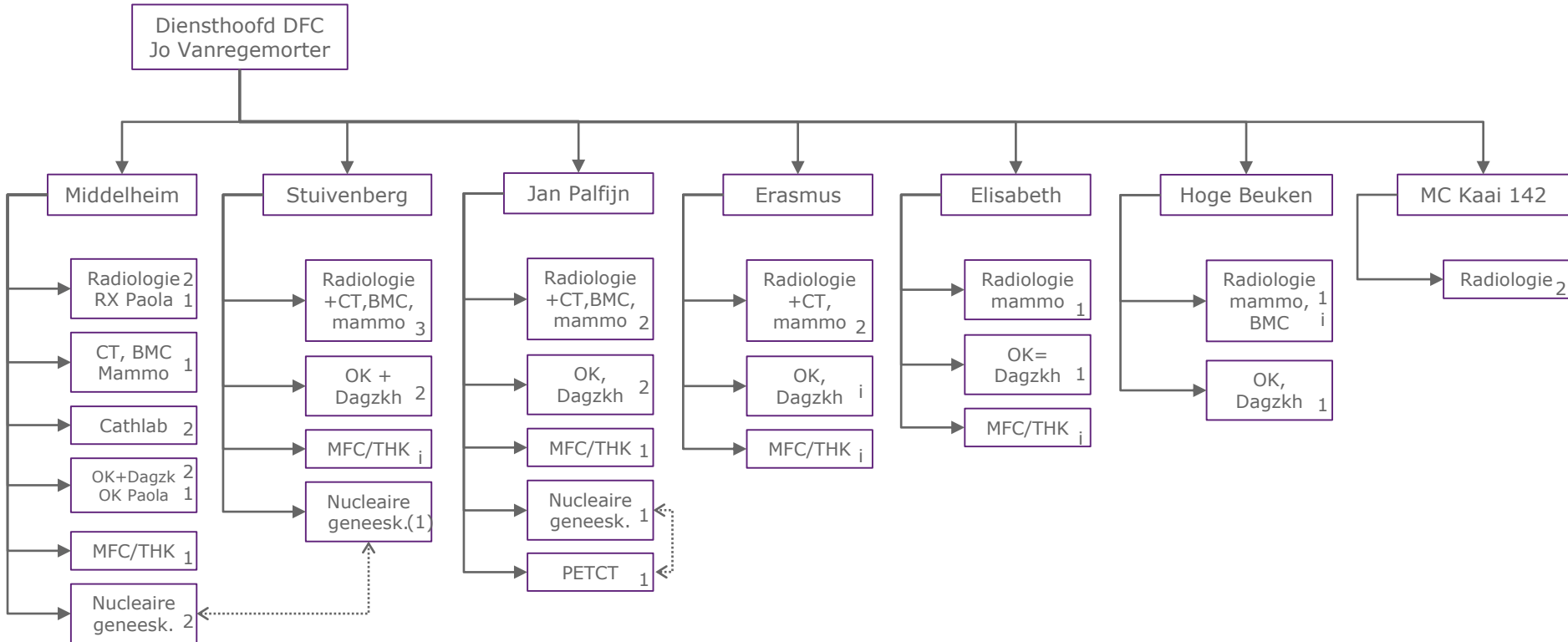

12

5

7

2

2

2

2

Bij de vermelde geschatte aantallen is rekening gehouden met het risico, de grootte en de spreiding van de afdeling, i = inbegrepen in andere afdeling indien haalbaar.

# Streamlining tasks

- ▣ ZNA 2016-...
  - ▣ Safety programme ionising radiation=all organisation wide procedures (quality portal JCI)
  - ▣ Local implementation SOP=team site
- ▣ January 2020: switch to new HPD
- ▣ In addition 2020
  - ▣ Description tasks RadProtAgent
  - ▣ Checklists for RPA (class 3 and class 2)
  - ▣ Periodic on-site checks of the RPE together with RadProtAgent(s)
  - ▣ Emergency diagramma "significant incident"

# Checklists as a guidance

☰ Checklist ASB radiologische toepassingen 🖨️

📁 Start

🔍 Periodieke controles klasse 3 : radiologische toepassingen

Interne en externe medewerkers die de gec...

Er is geen zichtbare schade aan de collecti...

Persoonlijke beschermingsmiddelen zijn be...

Wijzigingen aan het aantal of het type aanw...

Er is geen uitwendige schade aan de röntg...

Abnormale situaties met betrekking tot ion...

De voorziene aanduidingen en waarschuwi...

Dosimeters zijn tijdig gewisseld (maandeli...

De werk- en stralingsbeschermingsprocedu...

Een register van artsen, verpleegkundigen e...

Een lijst met personeelsleden die een infor...

De periodieke rondgang met de externe exp...

Persoonlijke beschermingsmiddelen zijn ge...

### Periodieke controles klasse 3 : radiologische toepassingen

**Interne en externe medewerkers die de gecontroleerde zone betreden beschikken over een persoonlijke dosimeter en zijn geïnformeerd over de gevaren van ioniserende straling.**

**Interne en externe medewerkers die de gecontroleerde zone betreden beschikken over een persoonlijke dosimeter en zijn geïnformeerd over de gevaren van ioniserende straling (wekelijks).**

**Verplicht**

Ja  Nee  nvt

OPMERKING PLAATSEN

**Er is geen zichtbare schade aan de collectieve bescherming (loodschermen, -glas, -deuren, -wanden). Er zijn geen aanpassingen aan de collectieve bescherming (wekelijks).**

**Verplicht**

Ja  Nee  nvt

< VORIGE VERZENDEN >

# Significant incident

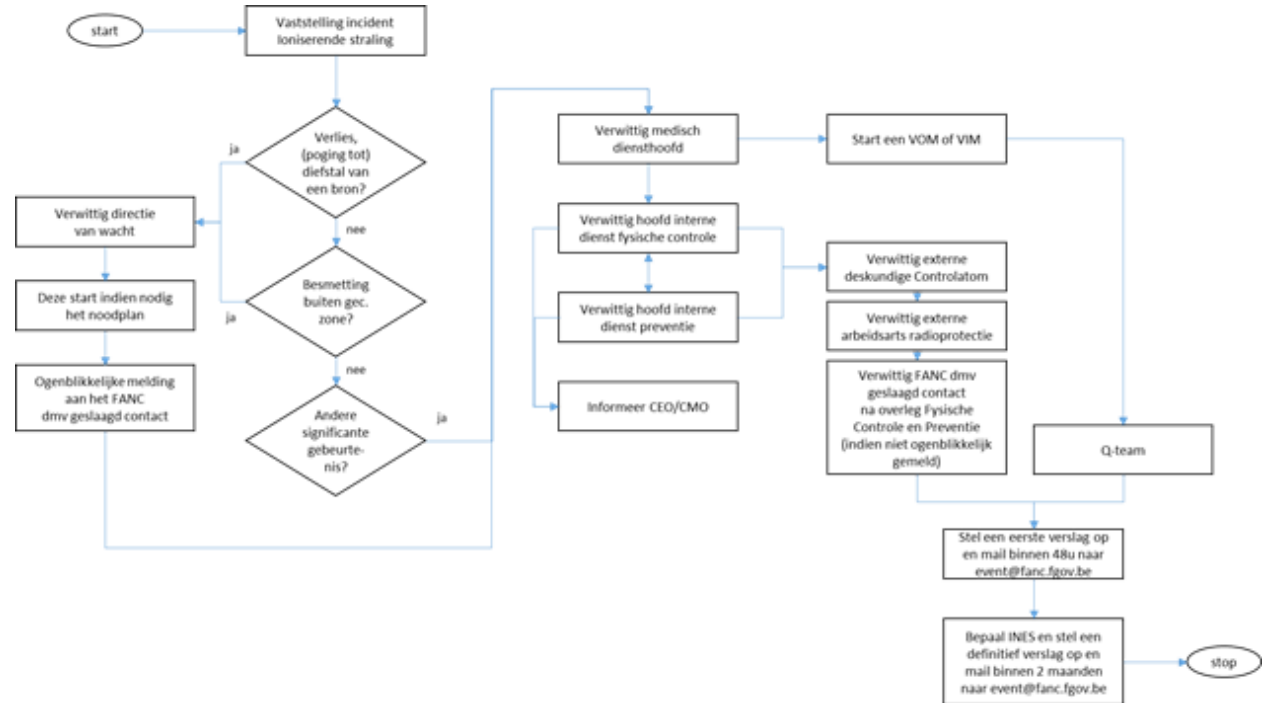



# Controlling tasks

- ▣ Committee of radiation protection agents + Teamsite
- ▣ Steering Committee Ionizing Radiation (quarterly)
  - ▣ Head DHP, Head Prevention, Occupational Health and Safety Agent, 1 RPA-head Radiology Dept.
- ▣ Extended Steering Committee Ionizing Radiation (annual)
  - ▣ Head DHP, Head Prevention, Prevention Advisor, 1 RPA-head Radiology Dept.
  - ▣ MD Head of a Medical Imaging Dept
  - ▣ Occupational Physician (advice)
  - ▣ CEO (if nessecary)
  - ▣ CMO (if nessecary)
- ▣ Bi-annual report to CEO

